

PORTADISC

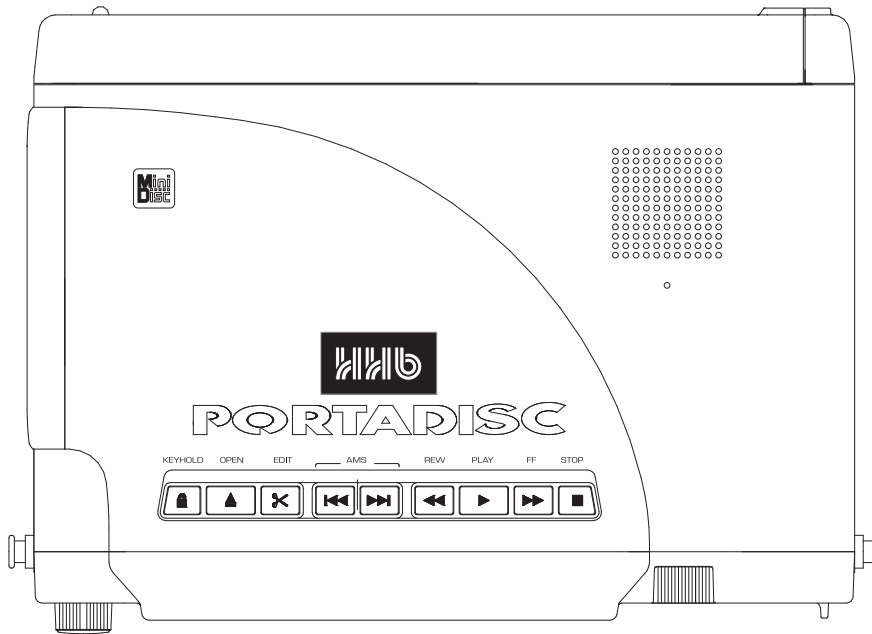

OPERATING INSTRUCTIONS

La versión en español del manual de operaciones la encontrará en la web de HHB – www.hhb.co.uk
La version Française de ce manuel d'utilisation est disponible sur le site web de HHB à www.hhb.co.uk
Eine deutsche Version dieser Bedienungsanleitung ist im Internet unter der Adresse www.hhb.co.uk erhältlich.



FIRST WE LISTEN

HHB MDP500 PORTABLE MINIDISC RECORDER

CONTENTS

PORTADISC MDP500 MiniDisc Recorder

INTRODUCTION	4	Setup Menu	17
Main Features	4	One Touch Setup	
PRECAUTIONS	5	How To Save	
SERVICE	5	How To Open	
TOP PANEL	6	Useful Recording Functions	17-18
FRONT PANEL	7	6 Seconds Pre-Recording	
SIDE PANELS	8	Input Monitor Function	
LCD DISPLAY	9	Peak Hold Meter	
NOTATION GUIDE	9	Overwrite Mode	
PREPARATION	10-14	Threshold Level Functions	18-19
Power Supply	10	Record Threshold Level Setting	
AC Adaptor		Auto Increment Function	
Nickel Metal Hydride Rechargeable Batteries		Auto-Start/Cut Recording Function	
Alkaline Batteries		Silence Trim	
Power Management		PLAYBACK	20
Battery Life Indicator		Normal Playback	20
Date & Time	10-11	Fast Search Function	
Date and Time Setting		Direct Track Select Function	
Date and Time Confirmation		Repeat Functions	20
Time Stamp Data Confirmation		Repeat One or Repeat All Function	
Initialising	11	Repeat A-B	
Initialising Procedure		Auto Pause Mode	20
Factory Default Settings		EDITING	21-23
Connections	12	Erase Function	21
Connecting Microphones to the XLR Input		Erase Only One Track	
Analog Source Recording via the XLR Input		Erase All the Tracks At Once	
Sending Analog Audio to External Analog Equipment		Erase Part of a Track	
Connecting to Digital Equipment via Coaxial or Optical		Divide Function	21-22
Sending Digital Audio to External Digital Equipment via		Combine Function	22
Coaxial or Optical Outputs		Move Function	22-23
Connecting With a Computer via the USB Interface		Disc & Track Naming	23
Remote Control		OTHER FUNCTIONS	24
LCD Display	13-14	Headphone Monitor	24
Display During Stop Mode		Digital Output	24
Display During Play Mode		Key Hold	24
Display During Record Mode		Copy Protection	24
Display Back Light		USB INSTALLATION	25
Display Contrast		Windows 98 / Windows 2000 Users	25
RECORDING	15-19	Mac Users (OS 9)	25
Recording From a Microphone	15	MENU OPERATION	26-27
Mic Attenuation Mode		DISPLAY MESSAGES	28
Basscut Mode		TROUBLESHOOTING	28
Limiter Mode		MD SYSTEM INFORMATION	29
Phantom Mode		TECHNICAL DATA	31
Recording From Line Sources	16		
Recording From Digital Sources	16		
Recording From Mono Internal Mic	16		
Basic Recording	16-17		
Mono Recording			

INTRODUCTION

PORTADISC MDP500 MiniDisc Recorder

Thank you for purchasing the HHB PORTADISC MDP500. This manual explains in detail how to use the MD recorder and also contains important advice on how to use it efficiently and safely. We recommend that you read this manual first before you start using the PORTADISC. We also recommend that you keep this manual in a safe place for easy access in the future.

MAIN FEATURES

- Versatile analog and digital in/out:

Analog	XLR balanced mic/line input, 2 channels RCA phono unbalanced line output, 2 channels
Digital in (SPDIF)	Coaxial Optical
Digital out (SPDIF)	Coaxial (ON or OFF switchable) Optical (ON or OFF switchable)
- Imports and exports audio data with a Macintosh or Windows PC via a Universal Serial Bus (USB) interface.
- The PORTADISC caters for professional microphones and is also equipped with a back-up internal mono microphone. Features include phantom power (+48V), attenuator, limiter, ganged limiter, AGC and high-pass filter (bass cut).
- Conforms to the MD standard (Adaptive Transform Acoustic Coding – ATRAC version 4.5) in addition to having a wide variety of MD recording functions: auto start/cut, auto pause, time stamp and 6-second pre record buffer.
- Five user set-up menus are available for storing input and system settings.
- Headphone monitor functions include Stereo, Mono L, Mono R and Mono Both.
- The PORTADISC has a built-in sample rate converter that automatically converts sample frequencies from 32kHz to 48kHz into the MD standard 44.1kHz.
- The editing facility offers editing options such as Divide, Combine, Move and Erase in addition to naming program titles and discs.
- The PORTADISC features 3-way power source and power management, with external 12-14V DC, 8 x AA alkaline batteries or 8 x Nickel Metal Hydride (NiMH) rechargeable batteries (supplied). The supplied batteries are high capacity 1550mAh NiMH cells, for optimum performance.
- Switchable auto power down function.
- You may recharge the supplied NiMH batteries in the PORTADISC with the AC adaptor provided.
- Two recording modes: 80 minutes in stereo mode or 160 minutes in mono mode.
- Automatic disc loading mechanism.
- Level margin display and peak hold level display.
- Date and time display.
- Parallel remote function.
- LCD display with back light.
- Internal monitor speaker.
- Internal mono microphone suitable for use when identifying tracks, etc.

PRECAUTIONS

PORTADISC MDP500 MiniDisc Recorder

The HHB PORTADISC is simple to use but, like all electrical equipment, care must be taken to ensure reliable, safe operation. The following points should always be observed in order to reduce the risk of fire or electric shocks:

- Do not expose the recorder to extreme conditions of smoke, water, moisture or excessive vibration.
- Do not insert objects (other than MD discs or batteries) or liquids into the recorder.
- Do not remove the PORTADISC's covers (except the battery compartment). This recorder employs a laser and there are no user-serviceable parts inside.
- Do not apply pressure or mount heavy objects on the recorder.
- Do not drop or apply extreme physical shock to the recorder.

- Disconnect the AC adaptor and remove the batteries when cleaning.
- Use only specified batteries, the AC adaptor and connection cables.
- Turn off the power before connecting the AC adaptor or replacing the batteries.

Please seek qualified service personnel advice if the PORTADISC appears to be operating abnormally. Power down the PORTADISC, disconnect the AC adaptor and remove the batteries if you notice any of the following:

- Unusual mechanical noises from the recorder.
- Liquid has been spilled into the recorder.
- The recorder has been dropped or the casing damaged in any way.

SERVICE

PORTADISC MDP500 MiniDisc Recorder

Should the HHB PORTADISC require service, it must be taken or sent to an HHB authorised dealer. Please retain the original packing for possible future use, and ensure the unit is suitably protected during transit. The manufacturer cannot accept responsibility for damage caused during transportation. In order to register ownership it is essential that you complete and return the user registration card supplied with this product.

All components used in the HHB PORTADISC are guaranteed against faulty materials or workmanship for a period of one year from the date of purchase. This warranty will become void if the product has been misused, modified or tampered with in any way. HHB shall not be liable for any consequential or incidental damages due to the failure of this product. In the unlikely event of a product failure please contact your local dealer.

Please record the following details:

Serial number:

Date purchased:

Dealer:

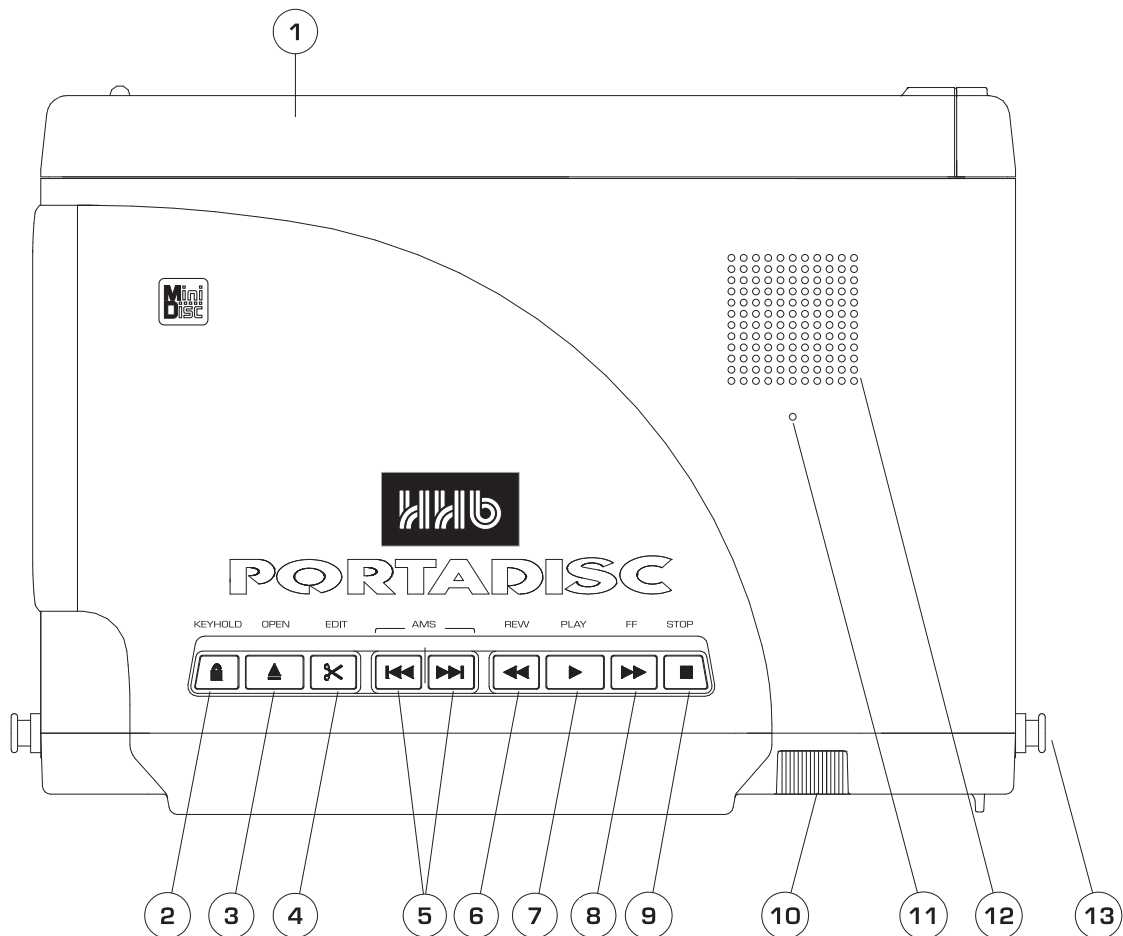

1 BATTERY COMPARTMENT

This cover slides off (from right to left in this view) and underneath is the battery caddy, holding 8 x AA batteries.

2 KEYHOLD

Use this button to avoid any accidental operation during recording. Each time you press the button for more than two seconds, the hold function changes from 'Key Hold ON' to 'Key Hold OFF' and vice versa. The following buttons can still operate even when the keyhold function is on: KEY HOLD, LIGHT, MARK, DISPLAY and POWER. The remote control connection will not be affected by this function; i.e., it is always enabled.

3 OPEN

Press this button to eject the MD disc. This function is disabled during recording.

4 EDIT

Use this button to enter the different edit modes.

5 AMS

Use the **◀◀** button to move back one or more tracks and the **▶▶** button to move forward one or more tracks. These buttons are also used in editing and naming.

6 REWIND

Rewinds the track during playback.

7 PLAY

Use this button to start playing back the track.

8 FAST FORWARD

Fast forwards the track during playback.

9 STOP

Use this button to stop the playback or recording operation.

10 RECORD VOLUME CONTROL

Dual concentric control for independent left and right level adjustment.

11 INTERNAL MONO MICROPHONE

12 MONITOR SPEAKER

13 SHOULDER STRAP ATTACHMENT POINTS

FRONT PANEL

PORTADISC MDP500 MiniDisc Recorder

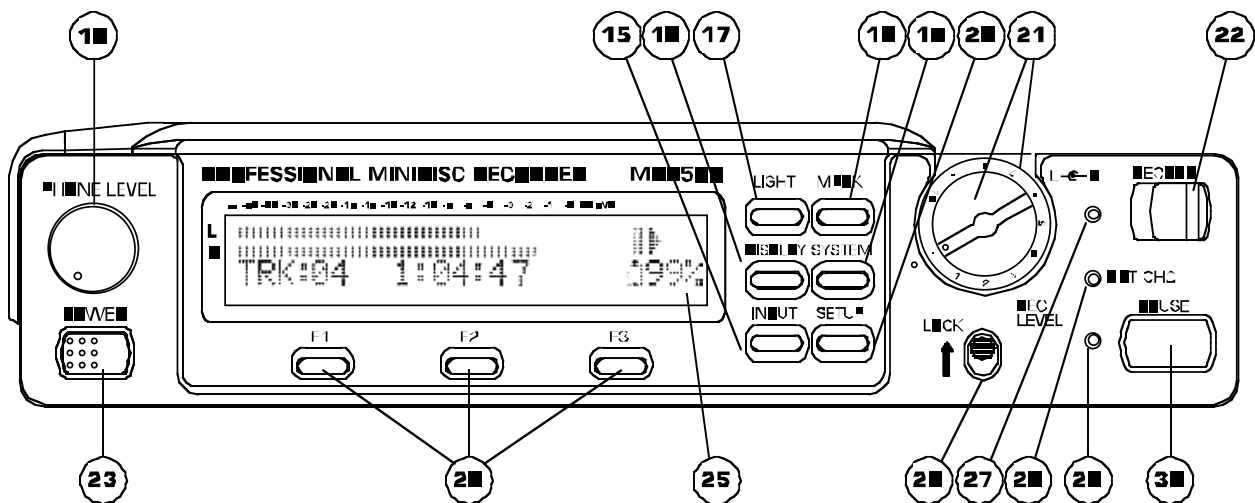

14 PHONE LEVEL

Adjusts the volume level for the headphones and monitor speaker. The control will pop out if you press it. The monitor speaker will not function during recording or when the headphones are connected.

15 INPUT

Changes the following input related settings:

- Input source: MIC, LINE, DIGITAL, INT MIC, OFF
- Options for MIC: MIC-Att, BASSCUT, LIMITER, PHANTOM
- Options for LINE: LIMITER
- Options for DIGITAL: COAXIAL, OPTICAL, USB input connections

16 DISPLAY

Changes the display menu through disc time, level margin, time & date.

17 LIGHT

Illuminates the display back light for a few seconds. Hold it down for more than two seconds in order for it to be continuously lit. Press it again to switch off the light.

18 MARK

Marks the track number manually during record mode and play/pause mode.

19 SYSTEM

Changes the following system settings: REC MODE, TRACK-INCREMENT, THRESHOLD LEVEL, AUTO-START/CUT, AUTO-PAUSE, PRE-RECORD, HEADPHONE MONITOR, OVERWRITE MODE, REPEAT MODE, DIGITAL OUTPUT and AUTO POWER DOWN.

20 SETUP

Changes the following setup options: OPEN SETUP, SAVE SETUP, CLOCK/DATE SETUP, DATE FORMAT, PEAK HOLD METER and DISPLAY CONTRAST. Use this button to save and recall set-ups. OPEN SETUP consists of five user set-ups, which can be used to store all the menu settings on the recorder, and three recording presets – MIC REC, LINE REC and DIGI REC.

21 REC LEVEL

Adjusts the analog recording level manually for mic and line inputs. This control does not affect the signal level when the AGC function is set to 'ON'. The outer control adjusts the left hand channel and the inner control adjusts the right hand channel. A friction lock between the two controls allows them to move together but also be adjusted individually.

22 RECORD

Slide this button to the right to enter record mode.

23 POWER

Press this button for one second to power ON and press for more than one second then release to power OFF. This button does not turn the power off during recording and TOC operations.

24 F1, F2, F3

Selects the parameters according to the corresponding set-up functions on the display above.

25 LCD DISPLAY

Shows level metering, disc information, timing information and all the menu select and control displays.

26 REC LEVEL LOCK

Mechanically locks the REC LEVEL knob position in order to avoid accidental adjustment. Slide this button up to lock.

27 REC INDICATOR

This LED will light up red in record mode and blink in record pause mode.

28 BAT CHG INDICATOR

This LED will light up green when charging the NiMH rechargeable batteries.

29 PAUSE INDICATOR

This LED will light up yellow in pause mode.

30 PAUSE BUTTON

Use this button to pause the record or playback operation. Pressing this button before pressing the record button will put the recorder into record pause mode, ready for recording.

SIDE PANELS

PORTADISC MDP500 MiniDisc Recorder

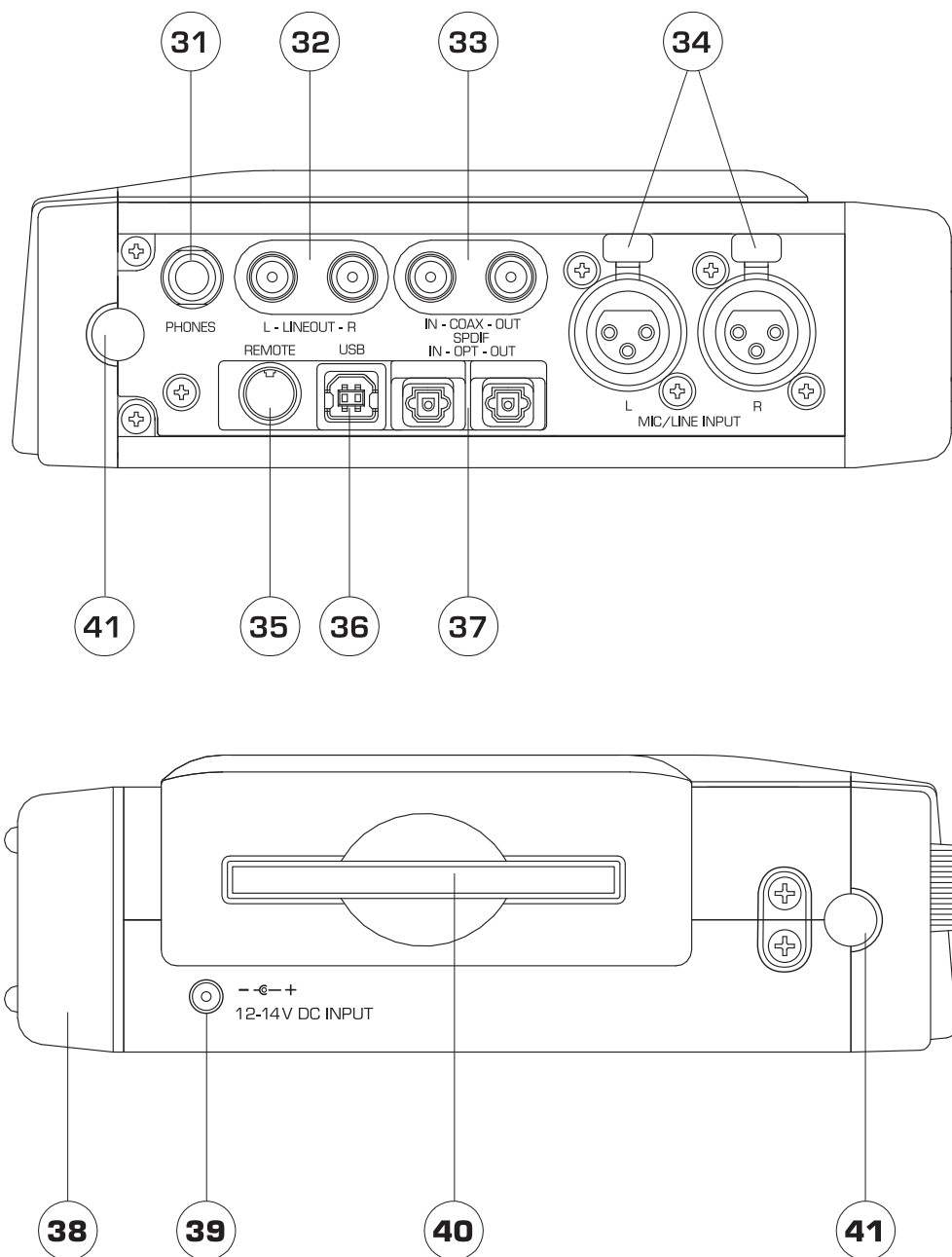

31 PHONES SOCKET

1/4" jack socket for headphone connection.

32 LINE OUT LEFT AND RIGHT CONNECTORS

(Unbalanced RCA phono.) To send analog output signals to other equipment.

33 COAXIAL I/O CONNECTORS

(Unbalanced RCA phono.) SPDIF digital coaxial connectors.

34 MIC/LINE CONNECTORS

(Balanced XLR.) To connect either MIC or LINE inputs.

35 REMOTE CONNECTOR

Parallel remote control connector.

36 USB CONNECTOR

USB interface port for a compatible computer.

37 OPTICAL I/O CONNECTORS

(TOSlink.) SPDIF digital optical connectors.

38 BATTERY COMPARTMENT

39 DC INPUT CONNECTOR

To connect the standard accessory AC adaptor, or an optional car adaptor. DC12-14V.

40 MINIDISC SLOT

A disc must be inserted into this slot with the arrow on the disc casing facing into the recorder.

41 SHOULDER STRAP ATTACHMENT POINTS

LCD DISPLAY

PORTADISC MDP500 MiniDisc Recorder

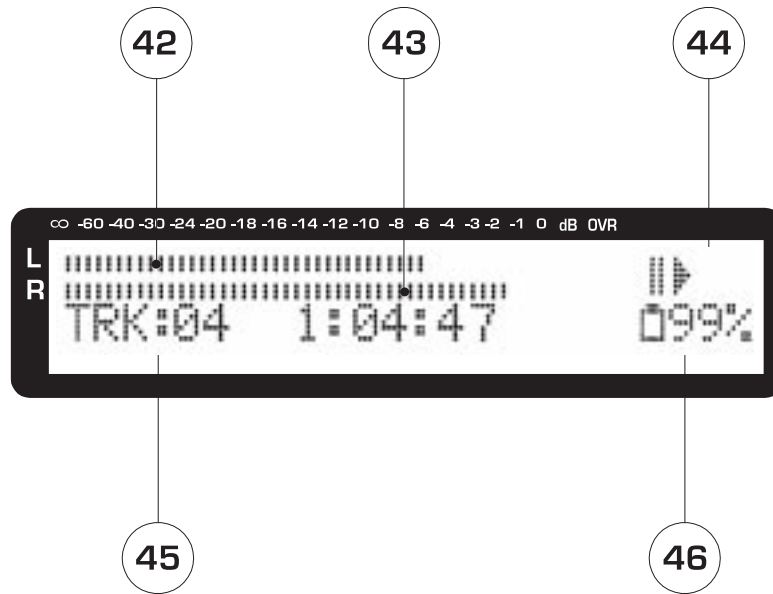

42-3 LEVEL INDICATOR

The bar meter shows the audio level in playback and record. (42) left hand channel (43) right hand channel.

44 RECORD/PLAYBACK MODE INDICATOR

The icons indicate pause, play and record modes.

45 DISPLAY MODE INDICATOR

Displays the track number, record/play time, remaining time, total recorded time, level margin, date and time.

46 BATTERY INDICATOR

Indicates the battery capacity remaining or whether the unit is connected to an external power source (DC IN).

NOTATION GUIDE

PORTADISC MDP500 MiniDisc Recorder

Throughout these operating instructions, the following notation will be used.

- When a button press is being illustrated in the text, it will be written in bold type, for example:

Press the **RECORD** button.

- When a word that will be shown on the PORTADISC's display is being illustrated in the text, it will be written in inverted commas, for example:

Press this button until 'SOURCE' is displayed.

POWER SUPPLY

AC ADAPTOR

Use the AC mains power supply to operate the PORTADISC by connecting the standard accessory AC adaptor (universal voltage 100-240 VAC) to the DC input connector. You can also use the AC adaptor to charge the rechargeable batteries within the recorder. If the rechargeable batteries are loaded and the charge switch, which is located on the back of unit underneath the battery caddy, is set to **ON**, the green charge LED on the front panel will light. The light will reduce in intensity once the batteries are charged. The batteries will fully charge in the PORTADISC overnight (at least 8 hours)

NICKEL METAL HYDRIDE RECHARGEABLE BATTERIES

Remove the battery cover and load the 8 supplied AA type NiMH batteries into the battery caddy in the

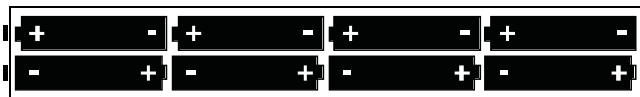

battery compartment as shown below.

Make sure the charging switch (located under the caddy) is set to **ON**. When charging the batteries, the green charge LED on the front panel will light. Other types of rechargeable batteries can be used but may not achieve the same high levels of performance.

CAUTION – Do not mix charged and discharged batteries or batteries of a different type (alkaline and NiMH). Ensure you install the batteries with the correct polarity.

ALKALINE BATTERIES

Remove the battery cover and load 8 standard AA type alkaline batteries into the battery caddy in the battery compartment. Switch **OFF** the charge switch.

CAUTION – Before installing alkaline batteries, ensure the charge switch is set to **OFF**. Do not mix new and used batteries or batteries of a different type (alkaline and NiMH). Ensure you install the batteries with the correct polarity. Do not attempt to recharge alkaline batteries as damage to the batteries or the PORTADISC may occur.

POWER MANAGEMENT

The PORTADISC can be set to automatically power down if it is left in STOP mode and none of the buttons have been touched for more than 10 minutes. This function can be enabled by recalling 'AUTO POWER DOWN ?' from the **SYSTEM** menu button.

BATTERY LIFE INDICATOR

When the PORTADISC is operated with batteries, the battery icon will be shown in the bottom right hand corner of the display. The PORTADISC will automatically power down if there is insufficient battery life remaining.

Display	Operation
DCIN	Operating with external power source
99%	Battery fully charged
40%	Battery life low

CAUTION – Be aware that different batteries have different discharge rates and, in some cases, the battery level indication may reduce very rapidly.

Battery life	Recording	Playback
Alkaline	2.5 hours	3 hours
NiMH battery	>3 hours	>3.5 hours

NOTE – Times given are approximate. The recording and playback time will be substantially shorter if manganese or low capacity Nickel Metal Cadmium (Ni-Cad) batteries are used.

Optimum performance will be achieved using the high capacity 1550mAh NiMH batteries supplied. If you choose to use alkaline batteries, we suggest you obtain the best quality, highest capacity AA cells available.

DATE & TIME

Before using the PORTADISC for the first time, please set the time and date, as this will enable the disc time stamp function facility to work correctly. The date format of your country may be set according to the following procedure:

1. Recall date format by pressing the **SETUP** button until 'DATE FORMAT' is displayed.
2. The current format will be displayed in the bottom left hand corner. Press the **F1** button until the date format which you want is displayed:
DD/MM/YY
MM/DD/YY
YY/MM/DD
3. Press **F2** ('SET') to select the required format and exit this page – should you wish to exit without making any changes, press **F3** ('EXIT') to return to the display page.

DATE AND TIME SETTING

1. Press the **SETUP** button until 'CLOCK/DATE SETUP?' appears.
2. If you press **F2**, the current set-up date and time will be displayed. For instance, in the DD/MM/YY format, 02/01/00 10:24:00 means 2nd January, 2000, 10 hours 24 minutes and 00 seconds AM.
3. The digit on the left will be flashing. Press **F1** or **AMS** $\overline{y} \overline{m} \overline{m}$ or $\overline{m} \overline{m} \overline{x}$ repeatedly until the number you want appears.
4. Once the correct number is flashing, press **F3** or **FF** to move the flashing digit to the right.
5. Repeat steps 3 and 4 to enter the required date and time.
6. Press **F2** to finish the setup.

DATE AND TIME CONFIRMATION

1. Press the **DISPLAY** button repeatedly until the time is displayed:

CLOCK	10:24:00
-------	----------

2. Pressing **DISPLAY** again shows the date:

DATE	02/01/00
------	----------

TIME STAMP DATA CONFIRMATION

When the PORTADISC plays back a disc that has a time stamp, the time stamp data will be displayed as follows:

1. Press **DISPLAY** three times during playback to recall the time of the recording.
2. The stamped time is displayed on the clock display page, showing minutes and seconds. The 2-digit number after the '/' symbol indicates the MD recorder manufacturer – this is 30 for the PORTADISC.

CLOCK	10:24/30
-------	----------

The stamped date is displayed in the DATE menu when **DISPLAY** is pressed once more:

DATE	02/01/00
------	----------

NOTE – Recorded clock and date information is not available until the Table of Contents (TOC) has been updated. This update only occurs when a disc is ejected, or if the powered down with the disc still in the PORTADISC.

INITIALISING

If functions on the PORTADISC behave abnormally at any time, it is a good idea to initialise the unit.

INITIALISING PROCEDURE

Power down the unit using the **POWER** button. Then, press **POWER** to turn the power on while simultaneously holding down the **F1** and **F2** buttons.

FACTORY DEFAULT SETTINGS

When the PORTADISC has been initialised or is newly purchased, its settings will be as follows:

INPUT menu	L	R
INPUT SOURCE	MIC	MIC
MIC-ATT	0dB	0dB
BASSCUT	OFF	OFF
LIMITER	ON	ON
PHANTOM	OFF	OFF

SYSTEM menu

REC MODE?	STEREO
TRACK-INCREMENT?	AUTO
THRESHOLD LEVEL	-30dB
AUTO-START/CUT?	NO
AUTO-PAUSE?	NO
PRE-RECORD?	NO
HEADPHONE MONITOR	STEREO
OVERWRITE MODE?	OFF
REPEAT MODE	OFF
DIGITAL OUTPUT?	OFF
AUTO POWER DOWN?	NO

SETUP menu

DISPLAY CONTRAST	+3
DATE FORMAT	DD/MM/YY
PEAK HOLD METER?	OFF

NOTE – Initialising the system will not change the USER1-5 memory settings.

PREPARATION cont.

PORTADISC MDP500 MiniDisc Recorder

CONNECTIONS

CONNECTING MICROPHONES TO THE XLR INPUT

If you use a stereo microphone, connect it to the XLR mic inputs. If you use a single microphone, connect it to either the left or right XLR mic input. (See page 15 for further information about recording from a microphone and page 17 for information about mono recording.) If you use a microphone that requires phantom power, set phantom mode to 'ON' by accessing the **INPUT** menu (see page 15).

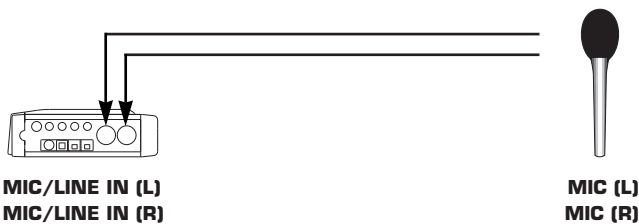

ANALOG SOURCE RECORDING VIA THE XLR INPUT

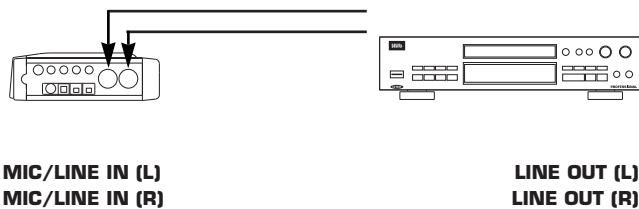

SENDING ANALOG AUDIO TO EXTERNAL ANALOG EQUIPMENT

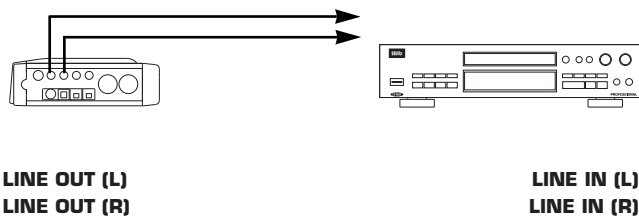

CONNECTING TO DIGITAL EQUIPMENT VIA COAXIAL OR OPTICAL

Digital source recording via COAXIAL or OPTICAL inputs.

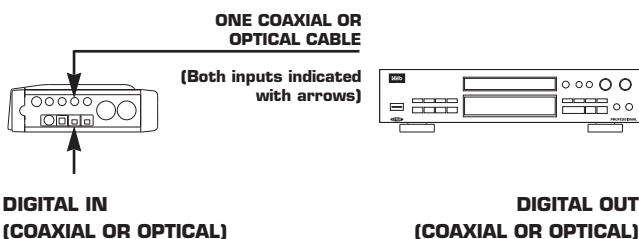

SENDING DIGITAL AUDIO TO EXTERNAL DIGITAL EQUIPMENT VIA COAXIAL OR OPTICAL OUTPUTS

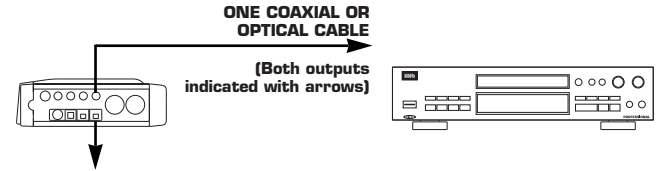

DIGITAL OUT
(COAXIAL OR OPTICAL)

DIGITAL IN
(COAXIAL OR OPTICAL)

NOTE – Ensure the digital output is turned 'ON' – see page 24 for details.

CONNECTING WITH A COMPUTER VIA THE USB INTERFACE

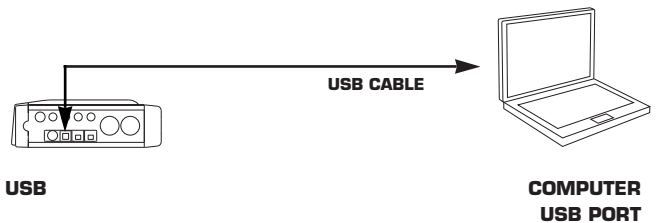

REMOTE CONTROL

The pin layout for the parallel remote connector is as follows:

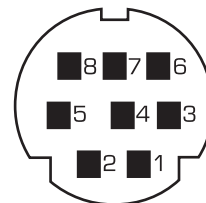

Parallel remote connector – pin configuration of Mini DIN remote control:

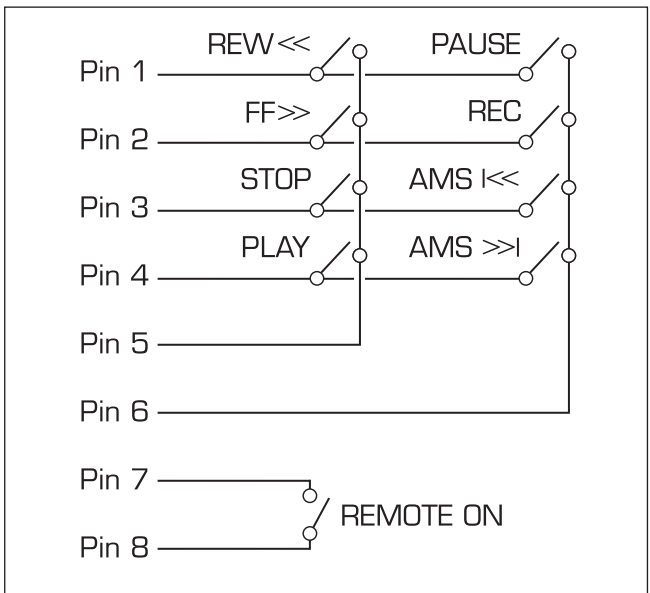

LCD DISPLAY

The PORTADISC can display information about the track, record/playback time, total recorded tracks plus time, disc space remaining, level margin, date and time in the display window.

DISPLAY DURING STOP MODE

With the PORTADISC in stop mode, the following information will be displayed each time you press the **DISPLAY** button:

Total number of tracks and total playback time:

TRK012	1:10:16	TO T	DCIN
--------	---------	------	------

MD time remaining:

DISC	0:03:44	REM	DCIN
------	---------	-----	------

Level margin:

MARGIN	L-60:R-60		DCIN
--------	-----------	--	------

The current time of day:

CLOCK	15:18:24		DCIN
-------	----------	--	------

The current date (the format will depend on your setting):

DATE	13/10/00		DCIN
------	----------	--	------

When you load an MD disc, the disc name, total track number and total playback time will be displayed automatically. Here is an example:

Disc name:

MONDAY'S NEWS

Total track number and total playback time:

TRK012	1:10:16	TO T	DCIN
--------	---------	------	------

Pressing **F1** will display the disc name (if available) during stop and playback and pressing **F2** will display the current track name (if available).

DISPLAY DURING PLAY MODE

With the PORTADISC in play mode, the following information will be displayed each time you press the **DISPLAY** button:

Playback track number and playback time:

TRK001	0:02:05		DCIN
--------	---------	--	------

Playback track number and track time remaining:

TRK001	0:01:02	REM	DCIN
--------	---------	-----	------

Level margin:

MARGIN	L-09:R-11		DCIN
--------	-----------	--	------

Time stamped (current time of the day if there is no time stamp recorded on the disc):

CLOCK	16:58/30		DCIN
-------	----------	--	------

Date stamped (the current date if there is no time stamp recorded on the disc):

DATE	21/09/00		DCIN
------	----------	--	------

DISPLAY DURING RECORD MODE

With the PORTADISC in record mode, the following information will be displayed each time you press the **DISPLAY** button:

Recording track number and recording time:

TRK004	0:04:05		REC DCIN
--------	---------	--	-------------

Recording track number and remaining MD time:

TRK004	0:11:25	REM	REC DCIN
--------	---------	-----	-------------

Level margin:

MARGIN	L-21:R-18		REC DCIN
--------	-----------	--	-------------

The current time of the day:

CLOCK	17:20:12		REC DCIN
-------	----------	--	-------------

The current date:

DATE	01/12/00		REC DCIN
------	----------	--	-------------

DISPLAY BACK LIGHT

Press **LIGHT** to turn on the display back light for 5 seconds or, if you press and hold the **LIGHT** button, the light will stay on permanently.

NOTE – We recommend minimal use of the display light when the PORTADISC is powered by batteries. This will maximise battery life.

DISPLAY CONTRAST

1. Press **SETUP** until 'DISPLAY CONTRAST' is displayed.

```
DISPLAY CONTRAST
+3          SET          EXIT
```

2. Press **F1** to choose the setting you want from '+1', '+2', '+3', '+4' and '+5' (5 is the darkest).
3. Press the **F2** button to confirm and then press **F3** to exit this page.

RECORDING FROM A MICROPHONE

1. Press the **INPUT** button once to recall 'SOURCE' mode in order to select the correct input source settings.

INPUT-L MIC	SOURCE SET	INPUT-R MIC
----------------	---------------	----------------

2. Press **F1** and **F3** to choose 'MIC'. Then press **F2** to confirm.

You can select the input source for both left and right channels individually:

SOURCE mode	Input source setting for left & right
OFF	Input source off
MIC	External microphone
LINE	Line input
DIGITAL	Digital input
INTMIC	Internal microphone

Once your input source is selected as 'MIC', the following settings will also be available by scrolling through the **INPUT** menu pages (by pressing **INPUT**):

MIC ATTENUATION MODE

In 'MIC-Att' mode, you can select the attenuation to be applied to the external microphones. Use this mode when using high output microphones.

1. Press the **INPUT** button once again to recall 'MIC-Att' mode:

INPUT-L 0dB	MIC-Att SET	INPUT-R 0dB
----------------	----------------	----------------

2. Press **F1** and **F3** to choose the attenuation from '0', '-15dB', and '-30dB'. Then press **F2** to confirm.

MIC-Att mode	Attenuation setting
0dB	No attenuation
-15dB	15dB attenuation
-30dB	30dB attenuation

BASSCUT MODE

With this mode you can select the bass roll-off frequency. Use this mode to minimise rumble, wind noise or humming induced by a power source.

1. Press the **INPUT** button once again to recall 'BASSCUT' mode:

INPUT-L OFF	BASSCUT SET	INPUT-R OFF
----------------	----------------	----------------

2. Press **F1** and **F3** to choose the bass cut frequency from 'OFF', '75Hz', and '150Hz'. Then press **F2** to confirm.

BASSCUT mode	Bass cut setting
OFF	Off
75Hz	Attenuate below 75Hz
150Hz	Attenuate below 150Hz

LIMITER MODE

This mode selects the limiter function and automatic gain control. In 'GANGED' mode, limiting on either channel will affect the other channel by the same amount, thereby maintaining the stereo image.

1. Press the **INPUT** button once again to recall 'LIMITER' mode:

INPUT-L ON	LIMITER SET	INPUT-R ON
---------------	----------------	---------------

2. Press **F1** and **F3** to choose the limiter setting from 'ON', 'OFF', 'GANGED', and 'AGC'. Then press **F2** to confirm.

LIMITER mode	Limiter setting
ON	On
OFF	Off
GANGED	Ganged limiter applied
AGC	Automatic gain control (REC LEVEL control is bypassed)

The Automatic Gain Control function automatically sets the record level of an analog input in order to achieve an optimum signal level. In this mode, the record level control is bypassed.

NOTE – If one channel is set to GANGED or AGC, then the other channel is automatically set to the same. If you subsequently decide to set either channel to limiter 'ON' or 'OFF', you will need to select 'ON' or 'OFF' for both channels using **F1** and **F3** before setting this with the **F2** button.

PHANTOM MODE

The PORTADISC can supply +48V phantom power to the external microphones.

1. Press the **INPUT** button once again to recall 'PHANTOM' mode:

INPUT-L ON	PHANTOM SET	INPUT-R ON
---------------	----------------	---------------

2. Press **F1** and **F3** to choose the phantom power setting from 'ON' or 'OFF'. Then press **F2** to confirm.

PHANTOM mode	Phantom power setting
ON	On
OFF	Off

RECORDING FROM LINE SOURCES

1. Press the **INPUT** button once to recall 'SOURCE' mode.

INPUT-L LINE	SOURCE SET	INPUT-R LINE
-----------------	---------------	-----------------

2. Press **F1** and **F3** to choose 'LINE'. Then press **F2** to set-up.

Once your input source is selected as 'LINE', the limiter setting will also be available by pressing **INPUT**. See the previous section for further details about the limiter function.

RECORDING FROM DIGITAL SOURCES

1. Press the **INPUT** button once to recall 'SOURCE' mode.

INPUT-L DIGITAL	SOURCE SET	INPUT-R DIGITAL
--------------------	---------------	--------------------

2. Press **F1** and **F3** to choose 'DIGITAL'. Then press **F2** to set-up.

Once your input source is selected as 'DIGITAL', the digital input mode setting will also be available by pressing **INPUT**:

1. Press **INPUT** again to recall DIGITAL INPUT? mode.

DIGITAL INPUT?		
COAXIAL	SET	EXIT

2. Press **F1** to select the correct digital input source from 'COAXIAL', 'OPTICAL' or 'USB'. Then press **F2** to confirm and **F3** to exit..

DIGITAL INPUT mode	Digital input setting
COAXIAL	Coaxial input
OPTICAL	Optical input
USB	Universal Serial Bus input

NOTE – If the digital source is interrupted (e.g., due to an intermittent connection), recording will automatically enter a record suspend mode and 'Din Unlock!' will be displayed. Recording will resume as soon as the signal is restored. If one channel is set to 'DIGITAL', the other channel will automatically be set to the same. If you subsequently decide to change this setting, you must first select the required source for both the left and right channels using **F1** and **F3** before pressing **F2** to confirm.

RECORDING FROM MONO INTERNAL MIC

1. Press **INPUT** button once to recall SOURCE mode.

INPUT-L INTMIC	SOURCE SET	INPUT-R INTMIC
-------------------	---------------	-------------------

2. Press **F1** or **F3** to choose 'INTMIC'. Then press **F2** to set-up.

The internal mono microphone is suitable for use identifying tracks, etc.

NOTE – If one channel is set to 'INTMIC', the other channel will automatically be set to the same. If you subsequently decide to change this setting, you must first select the required source for both the left and right channels using **F1** and **F3** before pressing **F2** to confirm.

BASIC RECORDING

1. Load the MD disc to be used for recording into the opening as shown below:

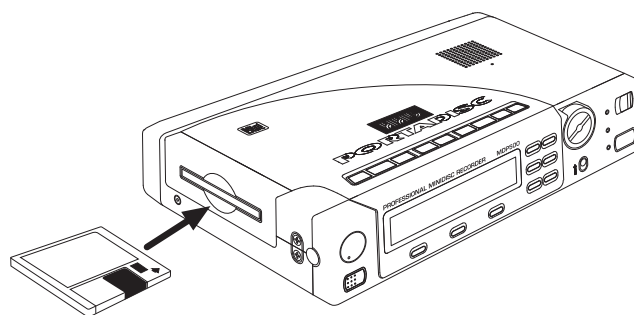

Load the MD disc with the arrows facing towards the slot.

To allow recording, the record protection tag on the disc must be in the correct position.

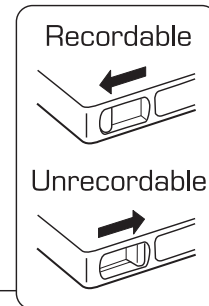
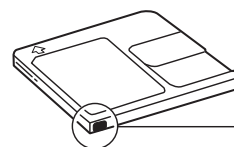

For best results, we recommend HHB MD74 or HHB MD80 (74 and 80 minute) professional MD media.

2. Adjust the **REC LEVEL** control for the appropriate recording level. This control is not active if the 'LIMITER' mode is set to 'AGC' (Automatic Gain Control), internal 'INTMIC' is selected, or if a digital signal is being recorded.
3. Slide the **RECORD** button to the right to start recording if you want to record immediately. However, if you first want to enter record pause mode, press the **PAUSE** button first, then slide the **RECORD** button. When you press the **PAUSE** button again, the PORTADISC will start recording:

- **RECORD** Start recording
- **PAUSE, RECORD** Record pause
- followed by **PAUSE** Start recording

- Adjust the recording levels so that the peak level meters do not go beyond 0dB (marked 'OVR' in the top right of the diagram below). If the recording level goes above 0dB, distortion to the recorded material may occur.

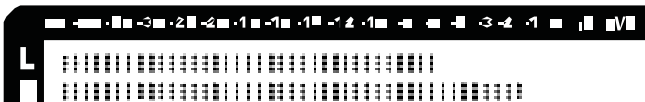

- Press the **STOP** button to stop recording. Or press the **PAUSE** button to pause recording. If you press the **PAUSE** button once again in record pause mode, the PORTADISC will start recording again.

MONO RECORDING

You can double the recording time on an MD disc by using the mono recording mode.

- Recall 'REC MODE ?' by pressing the **SYSTEM** button once.

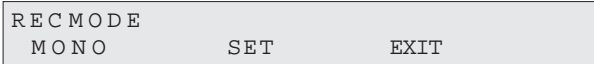

- Press **F1** to choose 'MONO'. Then press **F2** to confirm and **F3** to exit.

NOTE – The left and right channels will be added and recorded as a mono signal.

SETUP MENU

ONE-TOUCH SETUP

Use the **SETUP** button to quickly configure the PORTADISC for mic, line or digital recordings.

- Press the **SETUP** button once to recall 'OPEN SETUP' mode.



- The following setup options are available by scrolling through **F1** from the 'OPEN SETUP?' menu page. Press **F2** to select.

SETUP	PORTADISC settings
USER1 - USER5	5 user-defined settings
MIC REC	Microphone recording setup
LINE REC	Line recording setup
DIGI REC	Digital recording setup

You can save your input and system settings (which were made by using the **INPUT** and **SYSTEM** buttons) into 5 user memories and then easily recall them by opening the user memories.

HOW TO SAVE

5 user memories are available, named 'USER 1' to 'USER 5'.

- Make your record mode setting using the **INPUT** button and the **SYSTEM** button.
- Press the **SETUP** button until 'SAVE SETUP' is displayed.

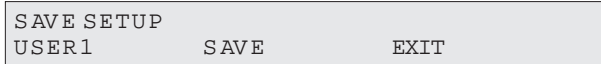

- Press **F1** to choose the user memory from USER 1-5. Then press **F2** to save.

HOW TO OPEN

You can open your pre-set record mode, which you saved in the user memories from USER 1-5.

- Press the **SETUP** button until 'OPEN SETUP' is recalled.

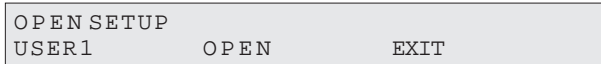

- Press **F1** to choose the user memory from USER 1-5. Then press **F2** to open.

USEFUL RECORDING FUNCTIONS

6 SECONDS PRE-RECORDING

This function enables you to record 6 seconds of audio from the internal memory buffer prior to pressing **RECORD**. This is a useful function for minimising the chance of missing the beginning of a take.

ACTUAL RECORDING BEGINS HERE	RECORD BUTTON IS PRESSED
TIME = 0 SECONDS	TIME +6 SECONDS

- Press the **SYSTEM** button until 'PRE-RECORD?' mode is recalled.



- Press **F1** until 'YES' is displayed. Then press **F2** to set-up.
- Enter record pause mode by pressing **PAUSE** before sliding the **RECORD** button.

CAUTION – For the pre-record mode to work, you need to wait at least 6 seconds after preparing the record pause mode in order to pre-load the buffer. The PORTADISC will not record the full 6 seconds of audio otherwise.

- Press **PAUSE** to start recording. The PORTADISC will record the audio, including 6 seconds of audio prior to the start of the recording.

- Press the **PAUSE** button to enter record pause mode. Or press **STOP** to stop recording.

INPUT MONITOR FUNCTION

You can monitor the incoming audio signal even when you are not recording (the input is always monitored in record pause mode).

- Eject the MD disc by pressing the **OPEN** button.
- Make your record mode setting using the **INPUT** and **SYSTEM** buttons.
- Slide the **RECORD** button to enter the monitor mode.
- The input audio signal will appear on the display meter and on both the analog and digital outputs, whichever analog or digital input source you choose.
- Press the **STOP** button to cancel the monitor mode.

PEAK HOLD METER

The level bar meter display shows the audio level with peak hold functions. It can be set as follows:

- Press **SETUP** until the 'PEAK HOLD METER' setup mode is recalled:

PEAK HOLD METER ?		
OFF	SET	EXIT

- Press **F1** to choose the setting you want from 'OFF', '2SECOND', and 'ON'.

PEAK HOLD METER mode	Peak hold setting
OFF	Peaks not held
2SECOND	Peaks held for 2 seconds
ON	Peaks held until the STOP or F3 button is pressed

- Press the **F2** button to set-up. Then press **F3** to exit the mode.

OVERWRITE MODE

It is possible to record directly over previously recorded tracks without needing to erase them first.

- Press **SYSTEM** until 'OVERWRITE MODE ?' is displayed.

OVERWRITE MODE ?		
OFF	SET	EXIT

- Press **F1** to select the overwrite setting from 'ON' or 'OFF'.
- Press the **F2** button to set-up. Then press **F3** to exit the mode.

- Press **PAUSE**, then select the track that you want to record over using the **AMS** γ_{01} and α_{01} buttons.

NOTE – If no track is selected, recording will begin automatically over track 1.

- Slide the **RECORD** switch to the right to enter record pause mode. 'Overwrite!' will be briefly displayed.
- Press **PAUSE** to begin recording. 'Overwrite!' will be briefly shown again.

If the new track is shorter than the track which is being overwritten, the remaining part of the old track will become the next track on the disc:

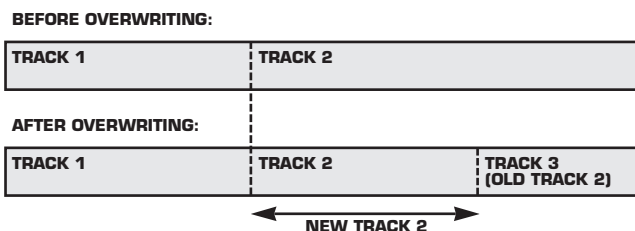

If the new track is longer than the track which is being overwritten, the next track will also be recorded over:

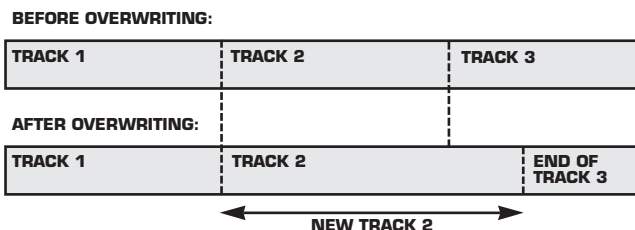

CAUTION – Please be aware that using overwrite mode can permanently remove existing recordings.

THRESHOLD LEVEL FUNCTIONS

The threshold level setting sets the levels from which both the auto increment and the auto start/cut functions operate.

RECORD THRESHOLD LEVEL SETTING

- Press the **SYSTEM** button until 'THRESHOLD LEVEL' is displayed.

THRESHOLD LEVEL		
-30dB	SET	EXIT

- Press **F1** to choose the threshold level from '-30dB', '-40dB', '-50dB' or '-60dB'. Then press **F2** to set-up and **F3** to exit.

AUTO INCREMENT FUNCTION

The function enables new tracks to be created automatically during recording.

1. Press **SYSTEM** until 'TRACK-INCREMENT?' is displayed.



2. Press **F1** to choose the auto increment setting from 'AUTO' or 'MANUAL'. Then press **F2** to set-up and **F3** to exit.

If set to 'AUTO', a new track will be created if the input signal level drops below and then rises above the level set in the threshold level menu page (see previous page for details). The signal level must drop for more than two seconds before rising again to create a new track:

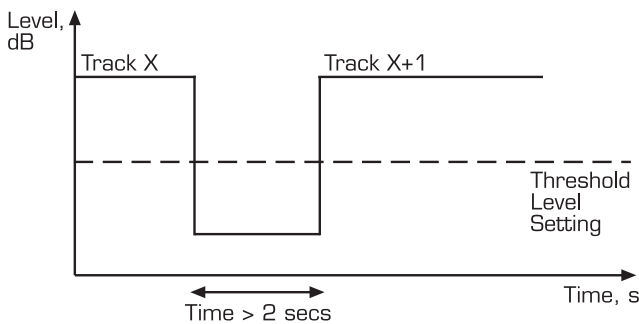

If set to 'MANUAL', this feature will be disabled and new tracks are only created when **MARK** is pressed. The **MARK** button will also function in 'AUTO' mode.

AUTO-START/CUT RECORDING FUNCTION

This function, ideal for environmental noise monitoring, operates as follows:

- The PORTADISC will automatically start recording when the threshold level setting is exceeded.
- Recording will automatically pause when the audio level drops below the threshold level setting for more than 30 seconds.

The PORTADISC must be in record pause mode for the auto-start function to operate.

1. Press the **SYSTEM** button until 'AUTO-START/CUT?' is displayed.

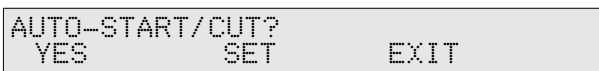

2. Press **F1** to choose 'YES'. Then press **F2** to set-up and **F3** to exit.

When using the auto-start/cut function with a digital input, the threshold level setting will default to -80dBFS, as illustrated below (with auto-start/cut on):

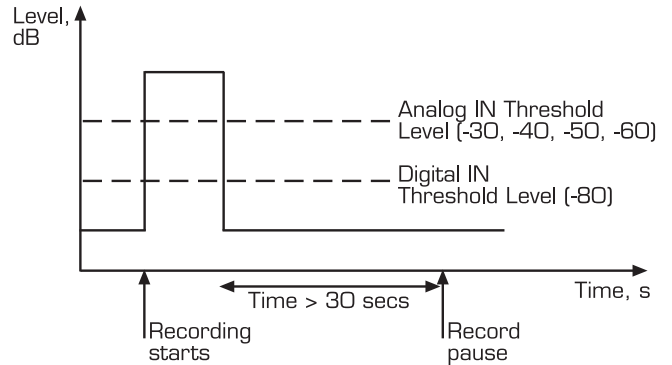

SILENCE TRIM

In addition, with auto-start/cut set to 'ON' during recording, if the audio level drops below the threshold level setting for more than 5 seconds and then rises above the threshold, the PORTADISC will 'silence trim' the silent region to 5 seconds in length. 'Silence Trim' will be briefly displayed.

Before silence trim:

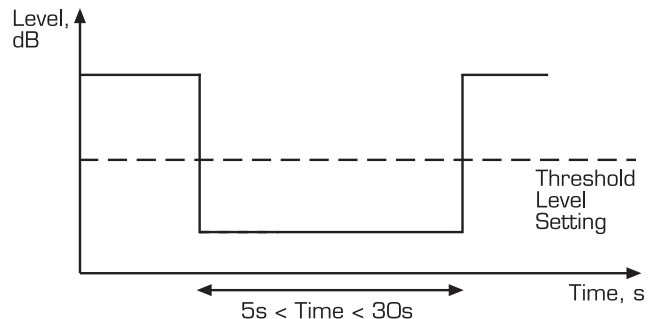

After silence trim:

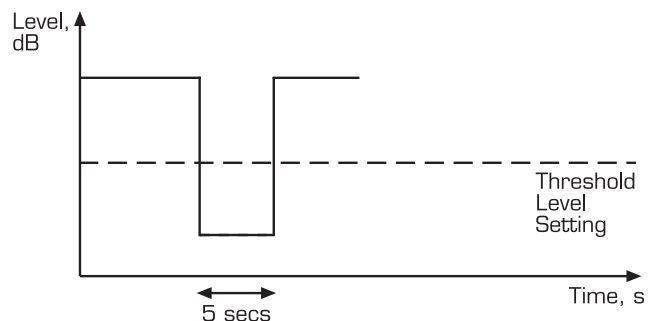

NORMAL PLAYBACK

1. Load the MD disc to be used for playback into the disc opening.
2. Press the **PLAY** button to start playback.
3. Press the **PAUSE** or **STOP** buttons to pause or stop playback.
4. During playback, press the **AMS** **▶▶** button once to locate the beginning of the next track. Press the **AMS** **◀◀** button once to locate the beginning of the current track. If you repeatedly press either of the AMS buttons, the track will continuously jump in the direction indicated. If the **AMS** **◀◀** button is pressed repeatedly from Track 1, the PORTADISC will 'wrap round' to the last track.

FAST SEARCH FUNCTION

You can playback a track in fast search mode by holding down either the **REW** or **FF** buttons. If you hold the buttons for more than 5 seconds, playback will enter an extra-fast search mode.

DIRECT TRACK SELECT FUNCTION

You can locate a track you want by its number in order to play it back.

1. During stop mode, press **AMS** **▶▶** or **AMS** **◀◀** repeatedly to choose the track number.
2. Press **PLAY** to start playback of the required track.

REPEAT FUNCTIONS

REPEAT ONE OR REPEAT ALL FUNCTION

You can repeatedly play back a particular track or all the tracks from the MD disc.

1. Press **SYSTEM** button until 'REPEAT MODE ?' is displayed.

```
REPEAT MODE ?  
ALL          SET          EXIT
```

2. Press **F1** to choose the repeat mode from 'ALL' or 'ONE'. Then press **F2** to set-up.
3. Press the **PLAY** button to begin playback.
4. The PORTADISC will repeatedly play back a particular track or all tracks accordingly. Whilst in the repeat mode, either 'ONE' or 'ALL' will be shown in the top right hand corner of the display.
5. If you want to cancel the repeat mode, choose 'OFF' for the repeat mode as described above.

REPEAT A-B

You can repeatedly play back a certain portion within a track.

1. Press the **SYSTEM** button until 'REPEAT MODE ?' is displayed.

```
REPEAT MODE ?  
A-B          SET          EXIT
```

2. Press **F1** to choose 'A-B'. Then press **F2** to set-up.
3. Play back the track you want to repeat. While playing back the track, 'A-B' will be shown in the top right hand corner of the display.
4. During playback, press the **F2** button at the time that you want the repeat function to start. As this point has now been registered as A, 'Repeat A-' will be shown momentarily on the display.
5. Continue playback or press the **FF** button to reach the place where you want the repeat function to end. Then press the **F2** button to set-up the repeat end point – point B. The PORTADISC will now repeat the portion between point A and point B. 'Repeat A-B' will be shown on the display momentarily while rewinding from B to A.
6. You can also change points A and B during replay. If you press **F2** again during replay, the point you had previously set as B will now become a new point A and you will be able to register a new point B by following the procedure mentioned in point 5 above.
7. If you want to reset the repeat A-B setting, press the **STOP** button, or change the playback track using the **AMS** **▶▶** or **AMS** **◀◀** buttons.

AUTO PAUSE MODE

With this mode, the PORTADISC will pause between tracks. This mode is useful if you want to playback particular tracks one at a time rather than continuously; ideal for broadcast or theatre productions.

1. Press the **SYSTEM** button until 'AUTO-PAUSE?' is recalled.

```
AUTO-PAUSE?  
YES          SET          EXIT
```

2. Press **F1** to choose 'YES'. Then press **F2** to set-up.
3. With auto-pause on, the PORTADISC will automatically pause at the end of the current track. If you wish to replay the same track, press **AMS** **◀◀** once, then press the **PLAY** button. If you want to start playing back the next track, simply press the **PLAY** button. The PORTADISC will stay in pause mode after playing back the next track.
4. To cancel the auto-pause mode, set this mode to 'NO' in the system menu.

The PORTADISC operates in four editing modes – erase, divide, combine and move. In addition, you can also label a disc or individual tracks. These different editing modes enable you to:

- go to a particular point in the middle of a track instantly,
- combine two tracks together to make them into one track,
- move a track wherever you want to,
- erase tracks.

ERASE FUNCTION

You can erase a track by recalling the track number. After erasing a track, the track numbers on all following tracks will automatically decrease by one.

This example illustrates erasing track number 2:

Track number	1	2	3	4
Track content	A	B	C	D
		ERASE		
New track content	A	C	D	

There are three ways which you can erase a recording:

1. Erase only one track.
2. Erase all the tracks at once.
3. Erase part of a track.

ERASE ONLY ONE TRACK

A particular track will be erased by recalling the track number.

1. Press the **EDIT** button on the top of the PORTADISC until 'ERASE ?' is displayed.

```
ERASE ?
TRK002  YES  EXIT
```

2. Press **F1** to recall the desired track, e.g., 'TRK002'. Then press **F2** to setup.
3. 'ERASE???' and 'TRK002' will appear in the display window. Press **F2** once again to erase the track.

```
ERASE ???
TRK002  YES  EXIT
```

4. The erase process has been completed. 'Complete!' will be shown in the display.
5. If you wish to continue erasing other tracks, repeat the procedure above.

ERASE ALL THE TRACKS AT ONCE

The function erases all the tracks recorded on the MD disc. The disc name and track names are also removed.

1. Press the **EDIT** button until 'ALL ERASE ?' is displayed.

```
ALL ERASE ?
          YES  EXIT
```

2. Press the **F2** button.
3. 'ALL ERASE???' will appear in the display window. Press **F2** once again to erase all the tracks.

```
ALL ERASE ???
          YES  EXIT
```

4. Once the all erase process has been completed, 'Complete!' and then 'Blank Disc!' will be shown in the display.

ERASE PART OF A TRACK

By using divide and combine functions in conjunction with the erase function, you can erase a particular part within a track (see the divide and combine functions later on for further information). This example illustrates erasing the middle part A2 in track A:

1. If there are two tracks already recorded as tracks A and B, divide track A into three parts:

```
A          B
DIVIDE
A1, A2, A3  B
```

2. Now, erase the A2 part.

```
A1, A3      B
```

3. Then, combine A1 and A3 to make one track.

```
A (= A1 + A3)  B
```

DIVIDE FUNCTION

The divide function divides a recorded track into two separate parts, effectively adding a new track number within a track for quick location.

This example illustrates dividing track number 2 into two parts, B1 and B2:

Track number	1	2	3	(4)
Track content	A	B	C	
		DIVIDE		
New track content	A	B1	B2	C

1. While replaying the track that you wish to divide, press **PAUSE** at the point where you want the divide.
2. Press the **EDIT** button until 'DIVIDE?' is displayed. Then press **F2** to setup.

```
DIVIDE ?
TRK001+000  YES  EXIT
```

- The display will repeatedly show the following messages one after another:

```
Rehearsal!
TRK001+000  YES      EXIT      ▶RH
```

```
Track OK!
TRK001+000  YES      EXIT      ▶RH
```

The PORTADISC will playback the audio at the dividing point repeatedly. If the audio plays from the correct point, skip to point 5 in this list.

- It is possible to adjust the divide point in 0.06 second steps by pressing either the **FF** button or **REW** buttons repeatedly. The adjustment range is from -128 to +127 within a track.
- Press **F2** to confirm.
- The divide process has been completed and 'Complete!' will be shown on the display. The PORTADISC will now start audio playback from the divided position. If the original undivided track had a track name, the track after the divide process will not have a name.

NOTE – If you want to cancel the divide function in the middle of the procedure, press either **F3** or the **STOP** button. You can return the divided track back to its original status by using the combine function.

COMBINE FUNCTION

This function combines two adjacent tracks into one track. This is useful when you want to combine short sections of recorded tracks into one. If you wish to combine two non-adjacent tracks, you first need to move them so they are next to each other using the move function (see next column).

This example illustrates combining tracks 2 and 3:

Track number	1	2	3	4
Track content	A	B	C	D
		COMBINE		
New track content	A	B+C	D	

- During stop mode, press the **EDIT** button until 'COMBINE?' is displayed.

```
COMBINE ?
TRK002      YES      EXIT
```

- Press **F1** to select the first track number of the two adjacent tracks that you want to combine (track 2 in this example). Then press **F2** to set-up.

- The display will now show the following messages one after another:

```
Rehearsal!
TRK002      YES      EXIT      ▶RH
```

```
Track OK!
TRK002      YES      EXIT      ▶RH
```

The PORTADISC will playback the end of the first track (TRK002) and the beginning of the second track (TRK003) repeatedly. If you are happy with the sound played back, skip to point 5 in this list.

- If the PORTADISC is not playing back the correct point in the audio, press either **F3** or **STOP** to cancel the function. Then, start the procedure again from point 1.
- Press **F2** to confirm.
- The combining process has been completed and 'Complete!' will be shown on the display. The PORTADISC will now start playing back the audio from the beginning of the combined tracks. If the first track before the combine process had a track name, this will now become the name of the combined track. The name of the second track will be deleted.

NOTE – If you want to cancel the COMBINE function in the middle of the procedure, press either **F3** or **STOP**. You can return the combined tracks back to their original status as separate tracks by using the divide function. If 'Impossible!' is shown on the display, you cannot use the combine function with the two tracks you have chosen. Due to a natural limitation of the MD system, you may not be able to use the combine function if you have used it too many times before.

MOVE FUNCTION

You can move a particular track to anywhere on the disc simply by changing the track order. The track numbers will be automatically re-aligned so that all the tracks have continuous numbers in numerical order.

This example illustrates moving track C to between tracks A and B.

Track number	1	2	3	4
Track contents	A	B	C	D
			MOVE	
New track contents	A	C	B	D

- During stop mode, press the **EDIT** button until 'MOVE >> ?' is displayed.

```
MOVE >> ?
TRK003      YES      TRK002
```

2. Press the **F1** button until the track number that you want to move is displayed. Then, press the **F3** button to choose the destination track number of the move function. In the example given in point 1, 'TRK003' will move to the 'TRK002' position.
3. Press the **F2** button to move the track.
4. Once the move function has been completed, 'Complete!' will be displayed.

NOTE – If you want to cancel the move operation in the middle of the procedure, press either **F3** or the **STOP** button. You can return the moved track back to its original position by going through move function again.

DISC & TRACK NAMING

You can label each MD disc and individual tracks with alpha-numerical characters.

1. Press the **EDIT** button until 'NAME INPUT?' is recalled.

```
NAME INPUT?
TRK001     YES     TRK002
```

2. Press **F1** to choose the track number that you wish to name. If you want to name the disc, rather than a track, continue pressing **F1** until 'DISC' appears on the display.
3. Press **F2** to set-up.
4. The digit furthest to the left on the display will start blinking to indicate that the digit is ready to edit. If the track or disc already had a title, this function can be over-ridden with a new title.

```
CHARA ^     SET     SHIFT
```

5. Press the **F1**, **AMS** **▶▶** or **AMS** **◀◀** buttons to scroll through available characters. Then press the **F3**, **REW** or **FF** buttons to shift the editing digit. Pressing **PLAY** clears all the characters and the **STOP** button cancels the edit mode.
6. After you have completed entering the name, press **F2** to set-up.

The following characters (and space) are available for naming discs and tracks:

```
ABCDEFGHIJKLMNOPQRSTUVWXYZ
abcdefghijklmnopqrstuvwxyz
0123456789
;:<=>?@^_!"#$%&'()*+,-./
```

NOTE – Pressing **F1** in play or stop modes will display the disc name, while pressing **F2** displays the current track name.

OTHER FUNCTIONS

PORTADISC MDP500 MiniDisc Recorder

HEADPHONE MONITOR

1. Press the **SYSTEM** button until 'HEADPHONE MONITOR' is recalled.

```
HEADPHONE MONITOR
STEREO      SET      EXIT
```

2. Press **F1** to select from 'STEREO', 'MONO-L', 'MONO-R' or 'BOTH' and then press **F2** to confirm. Press **F3** to exit.

DIGITAL OUTPUT

The digital output on the PORTADISC can be switched off, preventing digital howlround when connected in a loop with other digital equipment.

1. Press the **SYSTEM** button until 'DIGITAL OUTPUT?' is recalled.

```
DIGITAL OUTPUT?
OFF             SET      EXIT
```

2. Press **F1** to select either 'OFF' or 'ON' and then press **F2** to confirm. Press **F3** to exit.

KEY HOLD

This facility is provided to avoid any accidental operation during recording. Each time you press the button for more than two seconds, the hold function changes from 'Key Hold ON' to 'Key Hold OFF' and vice versa. The following buttons can still operate even when the keyhold function is on: KEY HOLD, LIGHT, MARK, DISPLAY and POWER. The remote control connection will not be affected by this function; i.e., it is always enabled.

COPY PROTECTION

The PORTADISC uses the Serial Copy Management System (SCMS), which only allows first generation digital copies of audio via the optical and coaxial digital inputs.

USB INSTALLATION

PORTADISC MDP500 MiniDisc Recorder

Universal Serial Bus (USB) audio transfer is provided for easy exchange of audio with a compatible computer. The format of the transfer is streaming audio – the software you are using on the computer will control the stored file format of the audio data.

The PORTADISC will automatically start any required software installation when connected via a USB cable to a computer.

WINDOWS 98 / WINDOWS 2000 USERS

1. Connect a USB cable between the PORTADISC and your computer.
2. Follow the installation instructions to install USB drivers (if required) for your computer. You may require your Windows installation discs. There is no software supplied with the PORTADISC.
3. Once the drivers are installed, the USB interface can be used. Please ensure the application you are using is selected in order to record from the USB audio source (normally found in options menu).
4. Should you wish to play back via USB from the computer to the PORTADISC, playback has to be selected to be USB audio. Most PC output paths will default to less than unity gain. To correct this, open the output gain control panel on the PC and select from options – playback USB Audio Device – then with the level page open ensure that both the Wave level control and the Output level control are set to maximum and un-muted.

MAC USERS (OS 9)

1. Connect a USB cable between the PORTADISC and your computer.
2. Follow the installation instructions to install USB drivers (if required) for your computer.
3. Once the drivers are installed, the USB interface can be used. Please ensure the application you are using is selected in order to record from the USB audio source (normally found in options menu).

MENU OPERATION

PORTADISC MDP500 MiniDisc Recorder

These diagrams show the basic menu operations. Changing a page displays the current settings, with the three functions keys (**F1**, **F2** and **F3**) selecting the parameters. When a parameter is flashing, pressing 'SET' will action this choice.

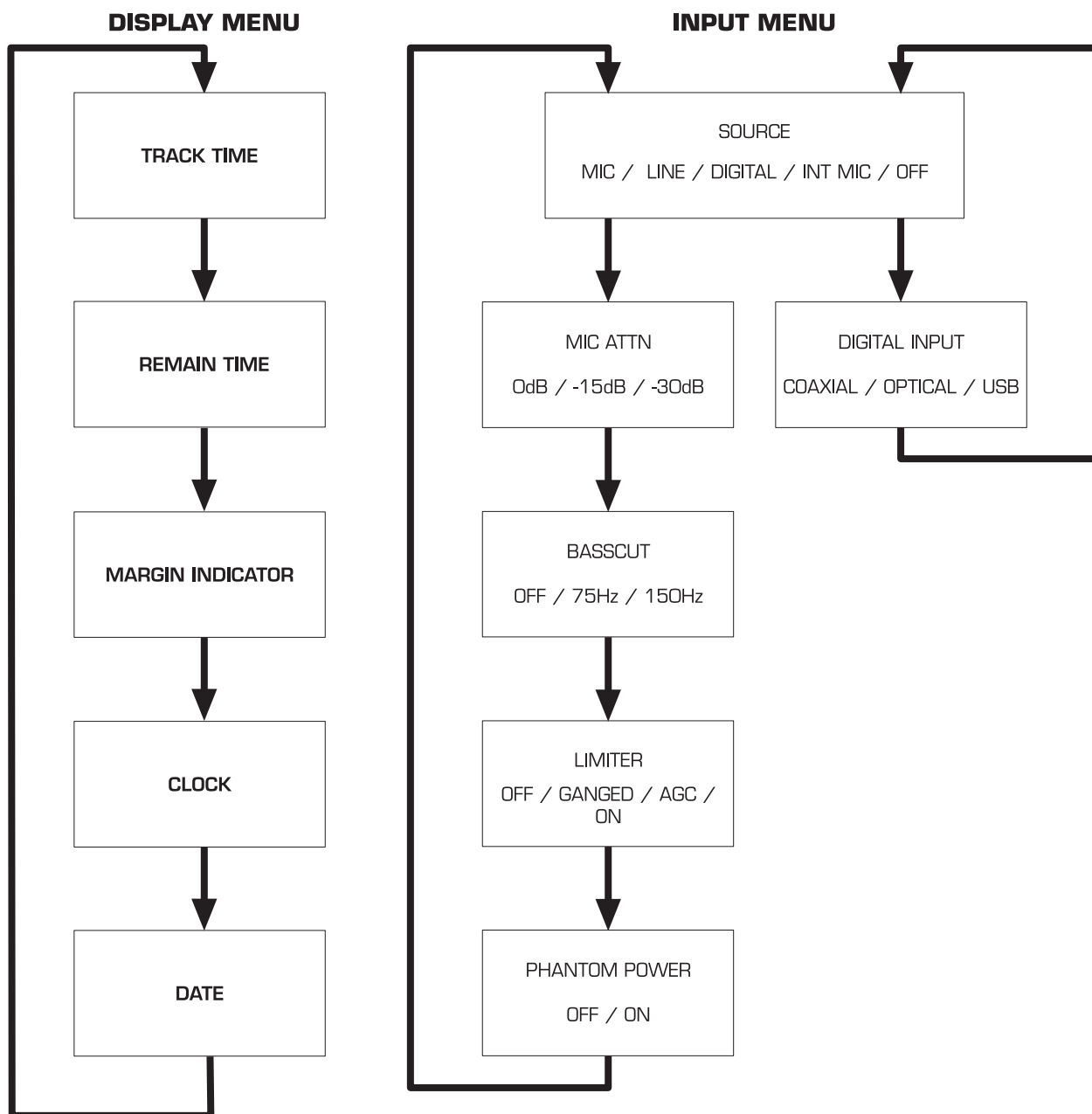

SETUP MENU

OPEN SETUP
MIC REC / LINE REC /
DIGI REC / USER 1...5

SAVE SETUP
USER1 / USER2 /
USER3 / USER4 / USER5

CLOCK / DATE SETUP
SET / EXIT

DATE FORMAT
DD/MM/YY / MM/DD/YY
/ YY/MM/DD

PEAK HOLD METER
OFF / 2 SECOND / ON

DISPLAY CONTRAST
MIN MAX

SYSTEM MENU 1

REC MODE
STEREO / MONO

TRACK INCREMENT
AUTO / MANUAL

THRESHOLD LEVEL
-30dB / -40dB / -50dB /
-60dB

AUTO-START/CUT
YES / NO

AUTO-PAUSE
YES / NO

PRE-RECORD
YES / NO

SYSTEM MENU 2

HEADPHONE MONITOR
STEREO / MONO-L /
MONO-R / BOTH

OVERWRITE MODE
ON / OFF

REPEAT MODE
OFF / ALL / ONE / A-B

DIGITAL OUTPUT
ON / OFF

AUTO POWER DOWN
YES / NO

DISPLAY MESSAGES

PORTADISC MDP500 MiniDisc Recorder

The PORTADISC may show the following messages while operating.

Blank Disc!	Nothing has been recorded on the MD disc – it may either be a brand new disc or it has been completely erased.
Cannot Copy!	Digital recording is not allowed due to the SCMS copy protect function.
Din Unlock!	The digital source is not powered on, or transmitting via SPDIF or the connection is faulty. If this warning appears, the PORTADISC will automatically enter a suspend record mode and will resume recording on a new track once the signal reappears.
Disc Error!	The loaded MD disc is damaged in some way.
Disc Full!	There is not enough space left on the MD disc so further recordings cannot be made.
Impossible!	The recording or edit operation is not allowed due to system limitations.
Key Hold!	The KEY HOLD function is set to 'ON'.
Name Full!	No more characters can be used in title mode as it has reached the maximum number permissible. Up to approx. 1700 characters can be used.

No Disc!	No MD disc is loaded.
No Track!	The disc has been named but there are no tracks recorded.
Protected!	The record protect tag is set to ON on the MD disc.
Retry Error!	Normal recording is not possible due to excess vibration or scratches on the MD disc.
Stand By!	If this is displayed when powering up, the previous recording was not made properly.
TOC Reading!	The unit is reading the TOC (Table Of Contents) from the MD disc.
TOC Writing!	The unit is writing the TOC onto the MD disc. When a disc has been recorded to or edited since last being inserted into the PORTADISC, it is necessary to update the TOC information on the disc before it is ejected. Do not power down or remove the power source when 'TOC Writing!' is displayed otherwise you may lose recorded information. If power is lost during recording or editing, the PORTADISC will automatically update the TOC when it is next powered on.

TROUBLESHOOTING

PORTADISC MDP500 MiniDisc Recorder

Before you seek advice from an HHB authorised dealer, follow the instructions below if you find any faults during operation:

NOT POWERING UP

- Replace batteries or recharge them.
- Check the battery polarity and battery case installation.
- Check connection of the AC adaptor, mains plug and DC plug.
- Remove the battery case and install it again.

PROBLEMS DURING OPERATION

- Initialise the unit by powering up while simultaneously holding down the **F1** and **F2** buttons.
- Replace the MD disc.

HIGH AUDIO NOISE

- Isolate the unit from any source of noise.

NO PLAYBACK

- There is a possibility of condensation – leave the unit powered ON for a few hours.
- Does the MD disc have audio already recorded on it?

NO RECORDING

- Check the record protection tag on the MD disc.
- Is the MD disc a recording MD disc?
- Check the audio source and power connections.
- Check the REC LEVEL knob position.
- Check the INPUT SOURCE setting.
- Replace the MD disc.

THE USB IS NOT WORKING

- Re-connect the USB connector.
- Try installing again.
- Check that the digital audio format on the PC is 16-bit, 44.1kHz.
- The Mac or PC is not fully USB compatible.

MD SYSTEM INFORMATION

PORTADISC MDP500 MiniDisc Recorder

The MD has a different recording system from compact cassette or DAT. Because of this, there may be circumstances when the following situations occur during operation. It should be noted that these are not faults.

- 'Disc Full!' message is showing although there still seems to be enough recordable time remaining.

The MD disc cannot record more than 255 tracks regardless of the total recording time. Delete some tracks or replace the disc.

- The recordable time does not increase even though the short tracks have been erased.

Any track shorter than 10 seconds may not be taken into account when calculating the remaining time. So erasing short tracks may not increase the recordable time.

- The sum of the recorded time and the time remaining does not match with the maximum recordable time of the MD disc.

A minimum of two seconds is the smallest recordable unit in an MD recording. Even when a track is less than two seconds long, the track will still occupy two seconds worth of space. This means that the actual recordable time will be reduced. Also, if there are scratches on the MD disc, the damaged area will be omitted from the recording. This will also cause a reduction in the recordable time.

- When over-writing on a used MD disc:

1. The time remaining display may not show the correct time or the recordable time remaining may be drastically reduced.
2. You may not be able to record new audio and erase the old material simultaneously.

In such cases, erase the previous recording using the EDIT mode.

- The time may not show correctly on the display with the mono format MD disc.
- Excess use of edit functions may cause audio corruption so that audio hiccups will occur on playback or fast search playback.
- A track that is compiled using the edit mode may not allow the combine function to operate.
- The time stamp will not work correctly if a power cut occurs while recording.

TECHNICAL DATA

PORTADISC MDP500 MiniDisc Recorder



GENERAL

Format MiniDisc digital audio system
 Disc MiniDisc
 Recording method Magnetic field variation overwrite
 Reading method Non contact optical pickup
 Laser Semiconductor laser (wavelength 780nm)
 Record/playback time
 Stereo mode 80 minutes max
 Mono mode 160 minutes max
 Rotation speed Approx 400-900rpm Constant Linear Velocity
 Sampling frequency 44.1kHz
 (with internal SRC to cater for 32kHz and 48kHz source signals)
 Coding ATRAC Ver 4.5
 Modulation system EFM (Eight to Fourteen Modulation)
 Channels 2
 Power requirement 12-14V DC
 Power consumption Approx 4.5W record, 3.5W playback
 Weight with batteries 2.0kg / 4lbs 7oz
 Weight without batteries 1.8kg / 3lbs 15oz
 Dimensions (WxHxD) 225 x 57 x 180mm/10 x 2.2 x 7.1 ins
 Internal speaker power 250mW

AUDIO

Frequency response 10Hz to 20kHz, -0.5dB
 Wow & flutter Below measurable limits
 Signal to noise ratio (playback) > 89dB bandwidth 22Hz to 22kHz
 Dynamic range (line input) > 96dB
 Microphone EIN > 122dB A-weighted
 THD & N @ 1kHz ref OdBFS < 0.02% bandwidth 22Hz to 22kHz

I/O CONNECTIONS

Analog connectors

Balanced mic/line input
 Connector type XLR 3: Pin 2 + Hot; pin 3 - Cold; Pin 1 Ground
 Mic input level for OdBFS (level control at max) -52dBu
 Line input level for OdBFS (level control at max) -2dBu
 Phantom power (mic inputs) +48V, 7mA

NOTE: The specifications and design of this product are subject to change without notice, due to improvements.

US patents 4,790,016 and 4,914,701 and foreign equivalents licensed from Dolby Laboratories Licensing Corporation.

Published by HHB Communications Ltd.
 Copyright © 2001 HHB Communications Ltd.
 All rights reserved.

Unbalanced line output

Connector type RCA phono
 Output level +8dBu @ OdBFS into >10k

Headphone output

Connector type 1/4" stereo jack
 Impedance 32
 Output power 15mW

Remote control

Connector type Parallel
 Connector type 8-pin mini DIN

Digital connectors

Coaxial digital input SPDIF
 Connector type RCA phono
 Input impedance 75
 Input level 0.5V p-p

Optical digital input SPDIF
 Connector type Toslink

Coaxial digital output SPDIF
 Connector type RCA phono
 Output impedance 75
 Output level 0.5V p-p

Optical digital output SPDIF
 Connector type Toslink

USB (Ver 1) input / output

Connector Type B
 Interface Windows 98/2000, Mac OS

ACCESSORIES

The following accessories are included as standard
 Soft case, carrying strap, battery caddy with 8 x NiMH
 rechargeable batteries, spare battery caddy, AC adaptor/charger,
 HHB MD80 MiniDisc, operating instructions, quick reference guide



Visit HHB online at www.hhb.co.uk

HHB Communications Ltd · 73-75 Scrubs Lane, London NW10 6QU, UK
Tel: 020 8962 5000 · Fax: 020 8962 5050 · E-Mail: sales@hhb.co.uk

HHB Communications USA LLC · 1410 Centinela Avenue, Los Angeles, CA 90025-2501, USA
Tel: 310 319 1111 · Fax: 310 319 1311 · E-Mail: sales@hhbusa.com

HHB Communications Canada Ltd · 260 King Street East, Toronto, Ontario M5A 4L5, Canada
Tel: 416 867 9000 · Fax: 416 867 1080 · E-Mail: sales@hhbcanada.com